

## **Study on the Resistance and Capacitance Characteristics of Concrete under Electro-osmosis**

\*Xiaodong Shen, \*\*Jun Lu, \*\*\*Xiao Xu, \*\*\*\*Meng Li, \*\*\*\*\* Shengbo Li, \*\*\*\*\*Yajiao Liu

\*Dept. of Military Installation, Army Logistics University,  
Chongqing 401311, China (806944035@qq.com)

\*\*Faculty of Urban Construction and Environmental Engineering, Chongqing University,  
Chongqing 400045, China (Corresponding Author: 1181367768@qq.com)

\*\*\*Dept. of Military Installation, Army Logistics University,  
Chongqing 401311, China (xuxiao\_1222@126.com)

\*\*\*\*Dept. of Military Installation, Army Logistics University,  
Chongqing 401311, China (22621591@qq.com)

\*\*\*\*\*Dept. of Military Installation, Army Logistics University,  
Chongqing 401311, China (57092272@qq.com)

\*\*\*\*\*Dept. of Military Installation, Army Logistics University,  
Chongqing 401311, China (lyj99164@126.com)

### **Abstract**

Electro-osmosis is an important method to reduce internal humidity of concrete, and humidity is an important factor affecting the electrical parameters of concrete. Under the influence of electro-osmosis electric field, the movement of water molecule changes the distribution of humidity inside the concrete, and has a great influence on the electrical parameters of concrete. In this paper, through the measurement and analysis of electrical parameters of concrete, explores the changes of electrical parameters of concrete with electro-osmosis process, this paper proposes a method for judging concrete humidity, provide a basis for the evaluation of effect of electro osmotic effect of concrete.

### **Key words**

Concrete, Electro-osmosis, Resistance measurements, Capacitance measurements, Concrete humidity.

## 1. Introduction

Electro-osmosis is a phenomenon of the directional movement of fluid in a porous solid medium under the action of electric field. It was discovered by F.F. Reuss (Russia) in 1803. In 1866, the first modeling of Electro-osmosis was performed by Hemholtz (Germany), i.e. the Hemholtz-Smoluchowski model [1]. Studies on the Electro-osmosis technology were carried out earlier in terms of bean curd strips dehydration [2], tomato sauce dehydration [3], sludge dehydration in the sewage treatment plant, and crude oil electric dehydration and the Electro-osmosis technology is also widely applied in these aspects. However, researches on the application of this technology in the underground engineering is relatively late. In 1988, Kjell Aage Utklev (Norway) expanded the technology and applied it to building waterproofing. In 1994, the US military set about to study the application of Electro-osmosis in the waterproofing of concrete structures. China introduced this technology in the early 1990s, and applied it to such projects as Zhengzhou high-voltage cable tunnel, Yunnan Tengmie mountain tunnel basement of Beijing Bishui Manor and other projects [6-7].

In order to make the Electro-osmosis function, electric fields must be established first. Therefore, in its application to the underground engineering, the electrode should be set on both sides of the underground engineering concrete [8]. The existence of both the positive and negative electrodes objectively formed the resistance and capacitance. The resistance and capacitance parameters change under the impact of the concrete condition, so these parameters can be taken as the important indicators to measure the concrete condition [9]. There are many factors influencing the resistivity of concrete, among which humidity has the greatest influence on the resistivity of concrete [10].

The specific resistance of completely dry normal concrete is within the range of  $10^4 \sim 10^9 \Omega \cdot m$ ; the specific resistance of the concrete whose degree of saturation is 70% is about  $500 \Omega \cdot m$ ; the specific resistance of the concrete with 100% degree of saturation decreases to about  $100 \Omega \cdot m$  [11]. The capacitance of the concrete is related to the electrode area, the dielectric constant of the concrete and the distance between the two electrodes [12]. The existence of water molecules in the concrete will affect the distance between the two electrodes and the dielectric constant, which will further affect the value of the capacitance. Therefore, the measurement of the parameters of resistance and capacitance composed by the electrodes can reflect the internal humidity of the

concrete from the project as a whole, thus providing basis for evaluating the progress of work of Electro-osmosis inside the concrete.

### 2. Equivalent Circuit Analysis

In the phenomenon of Electro-osmosis, the water molecules migrate under the action of electric field, so the establishment of electric field is the precondition for the Electro-osmosis to function efficiently. To avoid anode corrosion, titanium wire is generally adopted in the engineering for its prominent corrosion resistance and durability. However, its price is fairly high. Therefore, the low-cost graphite conductive mortar is also adopted to serve as the anode. The specific procedures of electrode construction are as follows: The titanium wire is adopted as the anode, which detours on the inner wall of the project or the graphite conductive mortar is used and laid in the full inner wall. Thanks to the electro chemical cathodic protection, copper bar or copper pipe can be adopted to serve as the cathode and laid in the rock mass or claypan outside the concrete via drilling. No matter what kind of electrode is adopted, it is to build an electric field extending from the inside to the outside of the concrete to promote the out-migration of water molecules. A multi-layer shape similar to the sandwich biscuit is objectively formed out of the arrangement of electrodes. Observe the profile of certain section shown in Figure 1, and it can be seen that there is the anode layer, concrete dielectric layer, rock mass or claypan layer, and cathode layer [13]. After analysis, the multi-layer structure is equivalent to the circuit in Figure 2. The meaning of each parameter is as follows:

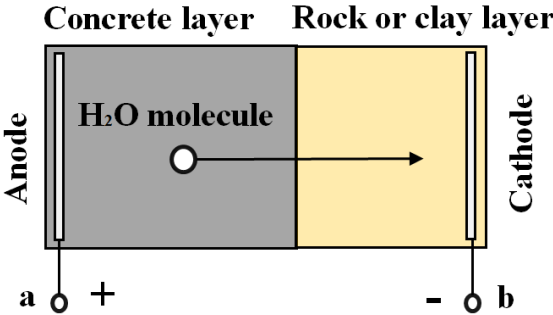

Fig.1. Electro-osmosis Arrangement Profile

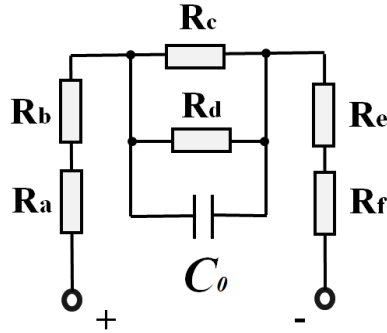

Fig.2. Electro-osmosis Equivalent Circuit Diagram

$R_a$  is the resistance of anode itself. If the titanium wire is adopted to serve as the anode, since the specific resistance of titanium is small ( $4.2 \times 10^{-3} \Omega \text{m}$  at  $20^\circ \text{C}$ ), its own resistance can be ignored; if the graphite conductive mortar is adopted to serve as the anode, its specific resistance depends on the mix ratio of graphite and mortar.

$R_b$  is the contact resistance between the anode and concrete, which depends on the degree of contact between the anode and the concrete and is also greatly influenced by the moisture content of the concrete. When the moisture content is high, the gaps between the anode and the concrete are all soaked by moisture. Since the water is somewhat conductive, the contact resistance between the anode and concrete is relatively small; when the concrete is dry, the contrary is the case.

$R_c$  is the dry resistance of the concrete and the rock (clay), which is related to the composition of concrete. Completely dry concrete has a higher resistivity.

$R_d$  is the channel resistance of the water molecules inside the concrete, which is related to the number of capillary channels inside the concrete, the water content of the concrete and the conductivity of the water molecules. The higher the water content is, the smaller the resistance is; the lower the water content is, the greater the resistance is.

$C_0$  is the capacitance between the anode and cathode, which is related to the overlap area, dielectric constant of the concrete and the distribution and distance of the two electrodes.

$R_e$  is the contact resistance between the cathode copper rod and the rock mass or soil layer. It is related to the degree of contact and moisture content. Considering that the water molecules are moving to the cathode under the action of Electro-osmosis, the area surrounding cathode keeps wet and its contact resistance can be basically stable.

$R_f$  is the resistance of the cathode itself. Copper rod or copper plate are usually adopted to serve as the cathode, so the resistivity is extremely low ( $1.68 \times 10^{-4} \Omega \text{m}$  at  $20^\circ \text{C}$ ), and the resistance is negligible.

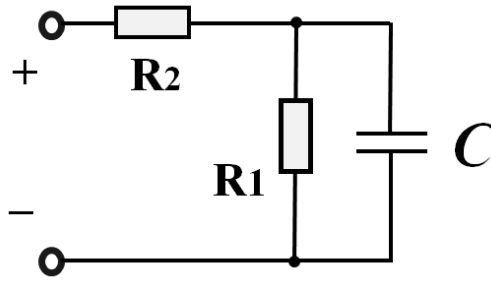

Fig.3. Equivalent Simplified Diagram of Electro-osmosis

Considering the resistance capacity parameters of the whole circuit,  $R_a$ ,  $R_b$ ,  $R_e$  and  $R_f$  are in series, while  $R_c$  and  $R_d$  are in parallel. And each resistance is distributed inside the concrete, which can't be measured one by one individually. Therefore, Figure 2 is simplified to the circuit in Figure 3, i.e. circuit of  $R_1$ ,  $R_2$  and  $C$ .

$R_1$  includes  $R_e$  and  $R_f$ , and  $R_2$  includes  $R_a$ ,  $R_b$ ,  $R_e$  and  $R_f$ . When the moisture content in the concrete changes,  $R_1$ ,  $R_2$ , and  $C$  are affected, and their parameters will change accordingly.

### 3. Experiment

#### 3.1 Experiment Preparation

Two pieces of experimental masonry unit in the size of  $5 \times 5 \times 30$ cm are made of ordinary concrete and clay. The thickness of the concrete layer and the claypan is 15cm respectively. The anode uses titanium wire and the cathode adopts copper sheet, which are preset when the masonry units are made. Before experiment, infiltrate the masonry units in water and let them stand for two days. The experiment was conducted in two groups simultaneously. In one group, the dc constant voltage is exerted and in another group, intermittent pulse voltage is exerted. The experimental equipment and measuring instruments include: dc constant voltage power supply QJ-3003SII, intermittent pulse power (homemade), multimeter HP-3468A, and oscilloscope TDS1001B-SC.

#### 3.2 Experimental Measurement and Calculation Method

There are many methods to measure the concrete resistance and capacitance parameters, including two-electrode method, four-electrode method, non-contact method, etc. [14-15] Two-electrode method is adopted here, i.e. the anode and cathode are used as the test electrodes. The calculation method adopts RC first order zero-state response method.

$R_1$ ,  $R_2$  and  $C$  are all the intrinsic parameters of the masonry units, which can be figured out through testing the port parameters. The procedures are as follows:

Short connect the port ab of the experimental masonry unit for some time to ensure that the charge at both sides of the capacitance is completely released through resistance, i.e. ensure that the capacitance  $C$  is at zero state. The same effect can be achieved when the port ab is disconnected, however, it takes longer.

In port ab, exert dc constant voltage  $U_s$ . Test continuously and record the port current  $I$ , until two electric currents in succession remain the same, as shown in Figure 4. Since there is resistance and capacitance in circuit, and capacitance has been in zero state, so after dc constant voltage is exerted, the typical first-order RC zero-state input response is formed. The exponential function of current  $i$  decreases along with the change of time, as shown in Figure 5.

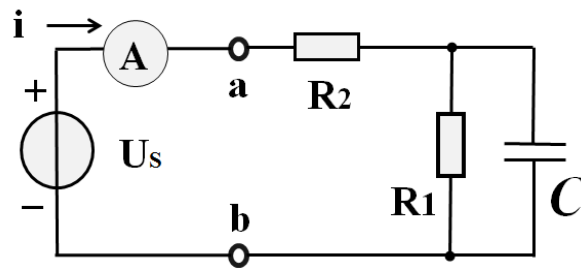

Fig.4. One Order RC Zero State Circuit

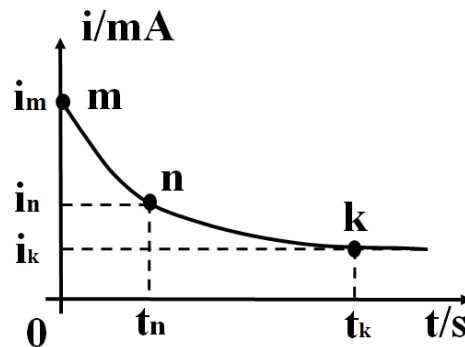

Fig.5. Current Variation

According to the zero-state response rule of RC circuit, the values of resistance  $R_1$ ,  $R_2$  and  $C$  can be calculated according to the current values and time of  $m$ ,  $n$  and  $k$ . The point  $m$  is the initial current  $i_m$  of the circuit; the point  $k$  is the steady-state current  $i_k$ , that is, the current no longer decreases with time; point  $n$  is the location where the current is 37.5% ( $i_m - i_k$ ). According to the zero-state response of the RC first order circuit of RC, the following equations are obtained:

$$i_m = \frac{U_s}{R_2} \tag{1}$$

$$i_k = \frac{U_s}{R_1 + R_2} \quad (2)$$

$$t_n = C \frac{R_1 R_2}{R_1 + R_2} \quad (3)$$

Using the simultaneous solution method, the values of  $R_1$ ,  $R_2$  and  $C$  can be obtained [16-17],  
Instructions:

(1) Due to the presence of resistance, it takes some time for the capacitance to be charged (this process is called transient state). The longer it takes, the more sufficient the measurement time will be. Due to the small area of the experimental masonry unit, the value of  $R_1$ ,  $R_2$  and  $C$  is small, and the duration of transient state is short. For laboratory measurement, oscilloscope can be adopted to record and reserve the waveform of the current for analysis. In practical Electro-osmosis seepage prevention works, the Electro-osmosis working area tends to reach hundreds or thousands of square meters. Due to the large size of the area, the value of the capacitance  $C$  also rises correspondingly, therefore, the transient state is longer, and the test time is more sufficient.

(2) When the experiment began, under the action of Electro-osmosis, the water molecules in the concrete moves towards the claypan. Despite the low speed, the value of  $R_1$ ,  $R_2$ , and  $C$  data will change slowly. Since the measurement time is very short compared with the entire experimental period (16 days), the data of  $R_1$ ,  $R_2$  and  $C$  are considered to be stable in this instant of measurement.

### 3.3 Experiment Results and Analysis

The first group (# 1) adopts dc constant voltage with a voltage amplitude of 36V; the second group (# 2) adopts the intermittent pulse voltage, with a voltage amplitude of 36V. The positive pulse time is 4 seconds, while the negative pulse time is 0.4 seconds, and the interval between positive and negative pulses is 0.2 seconds. After 16 consecutive days of energization and test, the curves of  $R_1$ ,  $R_2$  and  $C$  changing with time of the two groups are obtained.

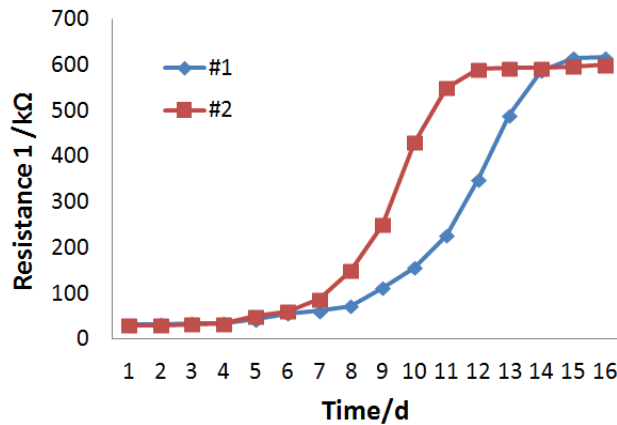

Fig.6. Variation Law of R1

As can be seen from Figure 6, ① the trend of change of resistance R1 with time is obvious, indicating that the water molecules in the concrete migrate under the influence of Electro-osmosis, and the concrete gradually dries, so the resistance changes obviously; ② the resistance value changes obviously when the wet concrete turns dry, suggesting that the moisture content of the concrete has a large impact on its resistivity. When the experiment starts, i.e. when the saturation ratio is 100%, the specific resistance is 1,2202Ωm; when the experiment ends, the specific resistance decreases to 88Ωm. The change ratio is about 138; ③ when intermittent pulse voltage is exerted to the concrete (#2 Group), the Electro-osmosis drainage effect is significantly faster than that of the concrete with dc constant voltage (#1 Group). It can be obviously seen from the figure that the resistance R1 of #2 Group is basically stable when the experiment lasts for 11 days, but for #1 Group, it takes almost 15 days to reach the same effect.

According to the mechanism of Electro-osmosis, the movement of water molecules to the cathode will starts from energization, but in the first six days of the experiment, the change of resistance R<sub>1</sub> is not obvious. The analysis shows that R<sub>1</sub> is formed by two resistors in parallel: the dry resistance of concrete and the solution resistance of each capillary inside the concrete. The dry resistance of the concrete is a fixed value, and there is a great number of capillary structures inside the concrete. When every capillary is filled with water molecules, each capillary is a conductive path, and each capillary conductive channel is in parallel. When the solution in a small number of capillaries migrates, the resistance of these capillaries gets larger. However, since in the parallel relationship, the total resistance must be less than the smallest resistance composing the parallel circuit, only when the water molecules of the majority of capillaries have migrated, and great change has happened to the resistance of most of the capillary channels, will the total resistance R<sub>1</sub> change sharply. Based on this analysis, the change rule in Figure 6 shows an important message:



when  $R_1$  rises sharply and tends to be stable, it indicates that the electric osmosis basically ends. At this point, the water molecules in the capillary of the concrete have basically entered the rock or clay layer.

Figure 7 is the variation rule of resistance  $R_2$ . It can be seen that ① the change of the pulse voltage group (# 2) is faster than the constant voltage group (# 1), indicating the electric osmosis of the pulse voltage group is faster than the dc constant voltage group; ② the data of the two groups both tended to be stable at the late stage (after the 5th day) of the experiment.

The elements that make up the resistance  $R_2$  include the resistance of the anode itself, the contact resistance of the anode, the contact resistance of the cathode, the resistance of the cathode itself and the wire resistance. Because the anode, cathode and wire are all good conductive materials with stable resistivity, the resistance value and change are both negligible. The water molecules move towards the cathode under the action of Electro-osmosis, and the surrounding area of the cathode keeps moist, so the cathode contact resistance remains relatively stable. The situation is different for anode contact resistance. After the water molecules move from anode to cathode, the anode gets wet from the initial dry state, so the contact resistance changes obviously due to the lack of infiltration of water molecules. As shown in Figure 7, the movement of the water molecules after energization made  $R_2$  change. Therefore, the increase of  $R_2$  in the short time after energization clearly indicates that the Electro-osmosis has already functions and that the water molecules have left the anode, leading to the increase of the anode contact resistance.

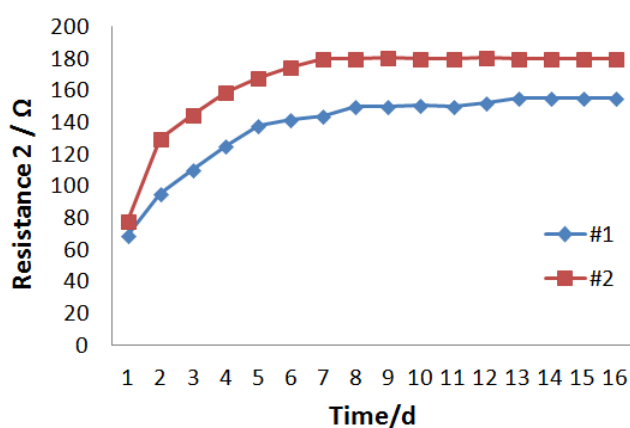

Fig.7. Variation Law of  $R_2$

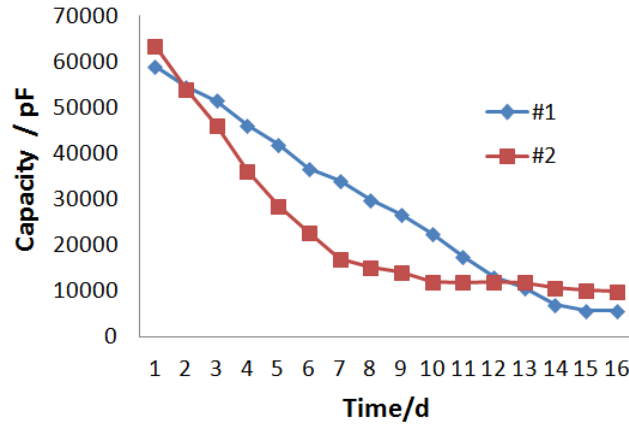

Fig.8. Variation Law of C

Figure 8 shows the change rule of the concrete capacitance. It can be seen that ① with the movement of the water molecules, the capacitance follows a linear change rule; ② the drainage speed of pulse voltage group (#2) is faster than that of the dc constant voltage group (# 1). It can be seen from the figure that the #2 curve tends to be stable much earlier than the #1 curve.\

The continuous decline and gradual stabilization of capacitance suggest that the function of Electro-osmosis tends to end. The contrast with the changing rule of resistance  $R_1$  in Figure 6 also clearly shows that Electro-osmosis tends to end at the 11th day for #2 Group and at the 15th day for #1 Group.

## Conclusion

(1) The moisture content of concrete has a significant impact on its resistance. When the water molecules move to the cathode, due to the shunting effect, the concrete resistance change is not obvious, but when the electro-osmosis is drawing to a close, the concrete resistance rises sharply. When the resistance tends to be stable again, the electro-osmosis completes. The variation of the resistivity of concrete can be taken as the criteria to judge the end of electro-osmosis.

(2) The water molecules move towards the cathode after the electro-osmosis functions. The water molecules surrounding the anode leaves the anode, so the anode contact resistance begins to rise. The gradual stabilization of the contact resistance of the anode suggests that the migration of water molecules surrounding the anode have completed. Therefore, the contact resistance of the anode can be taken as the criteria to judge the start of electro-osmosis.

(3) With the function of electro-osmosis, the capacitance  $C$  presents a tendency of stable declining, following a linear change rule, therefore, the value of capacitance can be viewed as the criteria to judge the water content and the electro-osmosis progress.

(4) In the electro-osmosis experiment of the concrete, the effect of the Intermittent pulse voltage is obvious than that of the constant voltage effect.

## References

1. Y.Q. Zhang, Research on dehumidification mode of air conditioning based on electro osmosis principle, 2007, Beijing, Beijing University of Technology, pp. 9-12.
2. R. Sun, L. Li, Z.G. Li, The effects of different electroosmotic methods on dewatering of bean curd, 2004, Food Science, vol. 25, no. 2, pp. 84-87.
3. S. Al-asheh, R. Jumah, F. Banat, K. Al-Zou'Bi, Direct current electro osmosis dewatering of tomato paste suspension, 2004, Food & Bioproducts Processing, vol. 82, no. 3, pp. 193-200.
4. L.C. Sun, S.T. Zhang, Electro-osmotic dewatering of biological sludge, 2004, China Water & Waste Water, vol. 20, no. 5, pp. 34.
5. P.L. Jia, S.S. Lou, X.L. Chu, Crude oil desalting and dewatering technology, 2010, Beijing, Sinopec Press of China, vol. 4, pp. 7-10.
6. J.B. He, Research on electro-osmotic technology for anti-seepage and moisture proof in military storage cavern and its application and management, 2012, Chongqing, Logistical Engineering University, vol. 5, no. 2, pp. 4-5.
7. N. Mukhopadhyay, Heat conduction model development of a cold storage using EPS insulation, 2016, Modelling, Measurement and Control B, vol. 85, no. 1, pp. 18-27.
8. X.D. Shen, Y.N. Zhang, Application of electro osmosis technology in engineering waterproof, 2013, Journal of Logistical Engineering University, vol. 29, no. 4, pp. 61-63.
9. B.Q. Dong, H. Yin, F. Xing, Study on resistance characteristics of carbon fiber reinforced cement based composites, 2007, Journal of Building Materials, vol. 10, no. 5, pp. 538.
10. Z.M. Gao, Y. Liu, Research and application of conductive concrete, 2011, Science & Technology Information, vol. 15, pp. 89.
11. H.B. Zhao, S.C. Zhao, Present status and progress of concrete resistivity research, 2010, Highway Traffic Science and Technology: Applied Technology Edition, vol. 3, pp. 56.
12. X.W. Ma, C.R. Niu, Y.K. Yi, Measurement of autogenous shrinkage of high strength concrete at early age, 2002, Cryogenic Building Technology, vol. 90, pp. 4-5.

13. Devi G.S.K.G, Raju G.S.N, Sridevi P.V, Design of concentric circular antenna arrays for sidelobe reduction using differential evolution algorithm, 2012, Modelling, Measurement and Control A, vol. 89, no. 1, pp. 45-57.
14. J.S. Qian, S.S. Xu, M.L. Li, Measurement and application of concrete resistivity, 2010, Journal of Shandong University of Science and Technology, vol. 29, no. 1, pp. 37-39.
15. H.J. Li, Y.J. Xie, Z.L. Yi, Research progress of concrete resistivity, 2011, Concrete, vol. 6, pp. 36-37.
16. Z.H. Qin, The Electro-technology, 2004, sixth ed. Beijing: Higher Education Press, pp. 78-99.
17. S. Chattopadhyay, S. Chattopadhyay, A. Das, Electrocardiogram signal analysis for diagnosis of apnea, 2016, Modelling, Measurement and Control C, vol. 77, no. 1, pp. 28-40.